

3450-K



- power to lift.

HMF Knuckle Boom Loader 3450-K

The HMF 3450-K Series – the Loader for Heavy Duty Lifting and demanding Lifting Tasks

- The HMF 3450 Series is a loader in the 34 tm range, which is designed specifically for users who need maximum lifting capacity both at long reach and close to the column.
- The 3450-K is a flexible loader, suitable for both hook applications as well as with hydraulic accessories application such as grabs and rotators.
- With a high lifting height and a dual link arm system, the 3450 Series is tailored to handling tall and bulky items.
- The loader is equipped with the RCL safety system as standard, and can be enhanced with additional safety systems such as; the EVS stability safety system, an integrated front stabilizer leg and an analogue temperature sensor.
- The loader series is available with a number of optional extras including; radio remote control, top seat, winch and Fly-Jib.

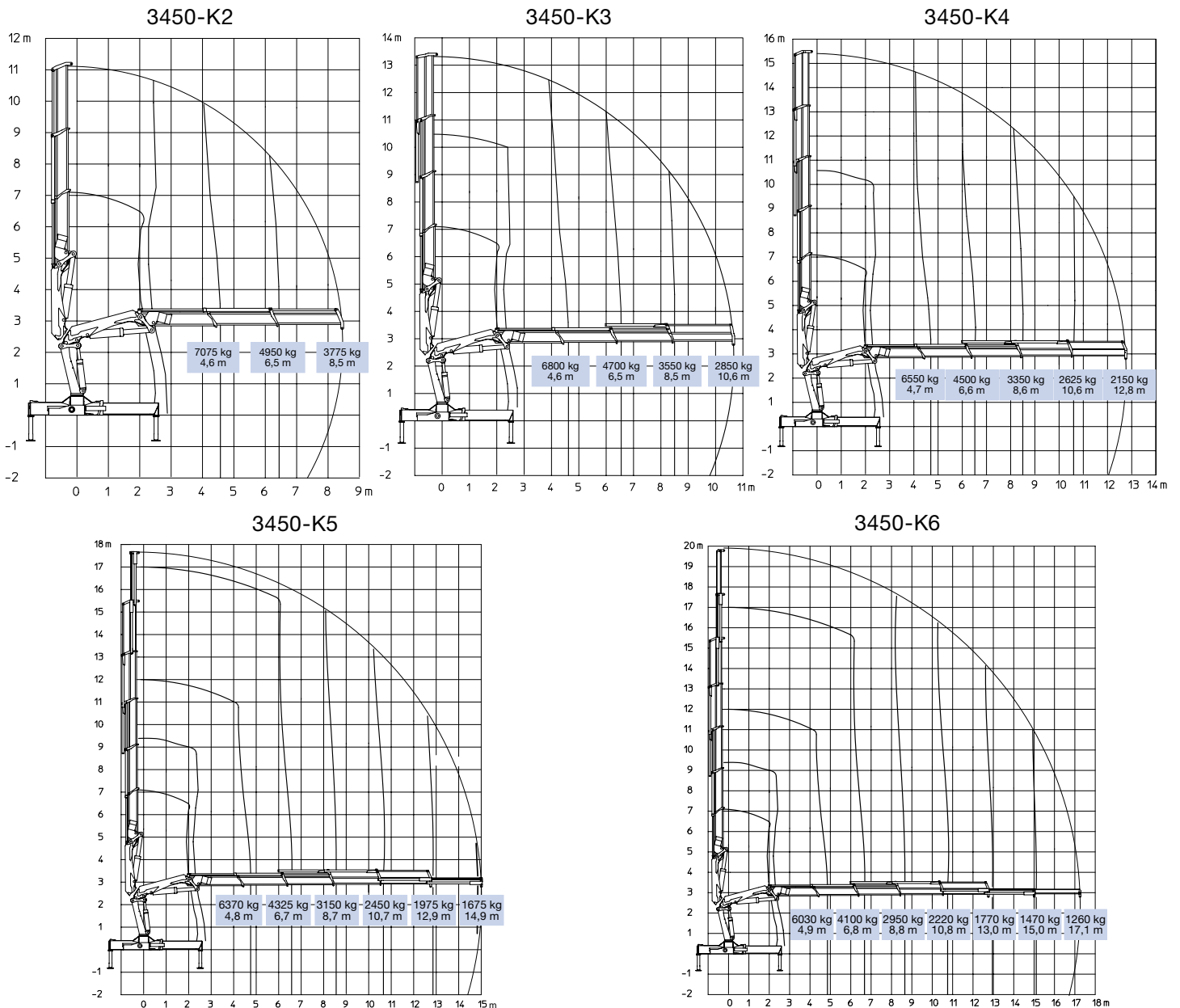

- power to lift.

Loading group B2		3450-K2	3450-K3	3450-K4	3450-K5	3450-K6
Load moment	tm	32.5	31.3	30.5	30.2	29.5
Hydraulic reach	m	8.6	10.7	12.9	15.0	17.2
Slewing torque	kgm	4800	4800	4800	4800	4800
Slewing angle	°	420	420	420	420	420
Height above chassis	mm	2425	2425	2425	2425	2425
Width, folded	mm	2500	2500	2500	2500	2500
Length of base, no extra valves	mm	1108	1108	1108	1250	1250
Stabilizer spread, standard	mm	5700	5700	5700	5700	5700
Stabilizer spread, double extension	mm	6700	6700	6700	6700	6700
Weight excl. stabilizer	kg	3575	3830	4050	4300	4500
Weight of stabilizers, standard	kg	500	500	500	500	500
Working pressure	MPa	26.0	26.0	26.0	26.0	26.0
Pump performance	l/min	65	65	65	65	65
Oil tank capacity, separate tank	l	160	160	160	160	160
Power consumption	kW	30	30	30	30	30
Hook height 1 m from column	m	2.8	2.8	2.7	2.6	2.5

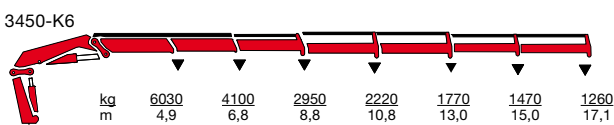
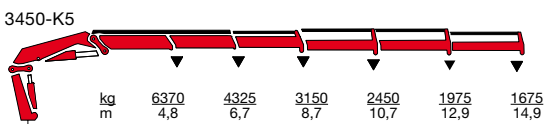
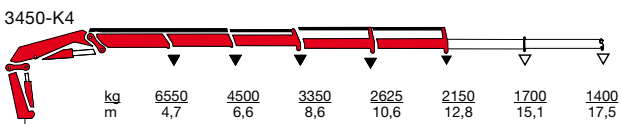
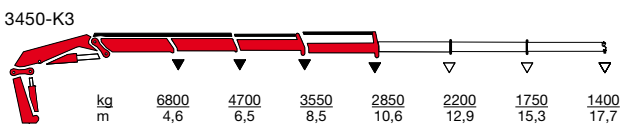
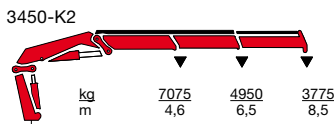
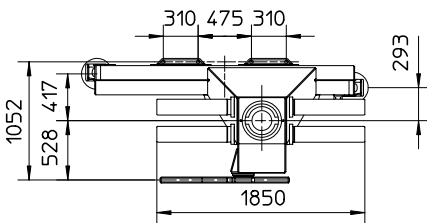
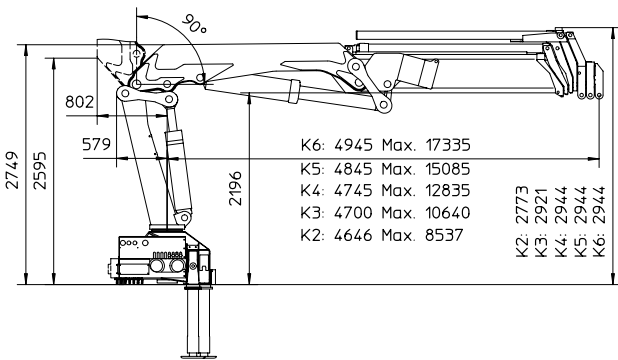

▼ Lifting capacity without manual extensions
 ▽ Lifting capacity with manual extensions

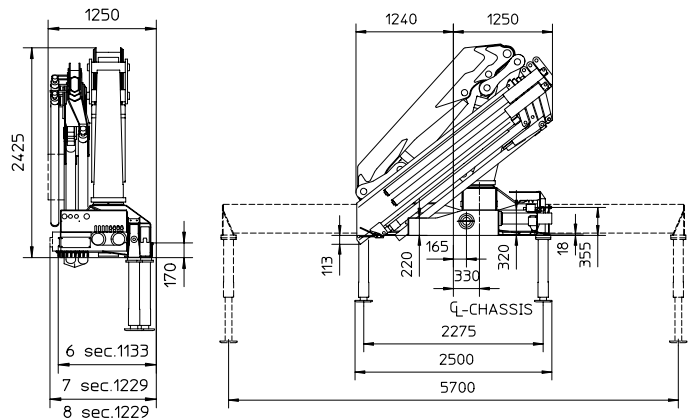

3450-K + fly-jib FJ900

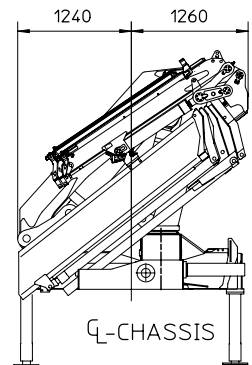
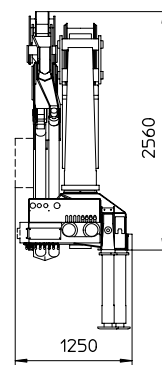

HMF Knuckle Boom Loader 3450-K

Technical data Fly-Jib		3450-K4 + FJ900-K2	3450-K4 + FJ900-K3	3450-K4 + FJ900 K4
Hydraulic reach	m	19.0	26.4	26.0
Lifting capacity at max. hydr. reach	kg	950	375	325
Reach with 1 manual extension	m	-	22.5	24.1
Reach with 2 manual extensions	m	-	24.4	26.0
Reach with 3 manual extensions	m	-	26.4	-
Max. lifting capacity with 1 manual extension	kg	-	600	425
Max. lifting capacity with 2 manual extensions	kg	-	450	325
Max. lifting capacity with 3 manual extensions	kg	-	375	-
Height above chassis, folded	mm	2560	2560	2560
Width, folded	mm	2500	2500	2500
Length of loader	mm	1250	1250	1250

3450-K4 + FJ900-K2

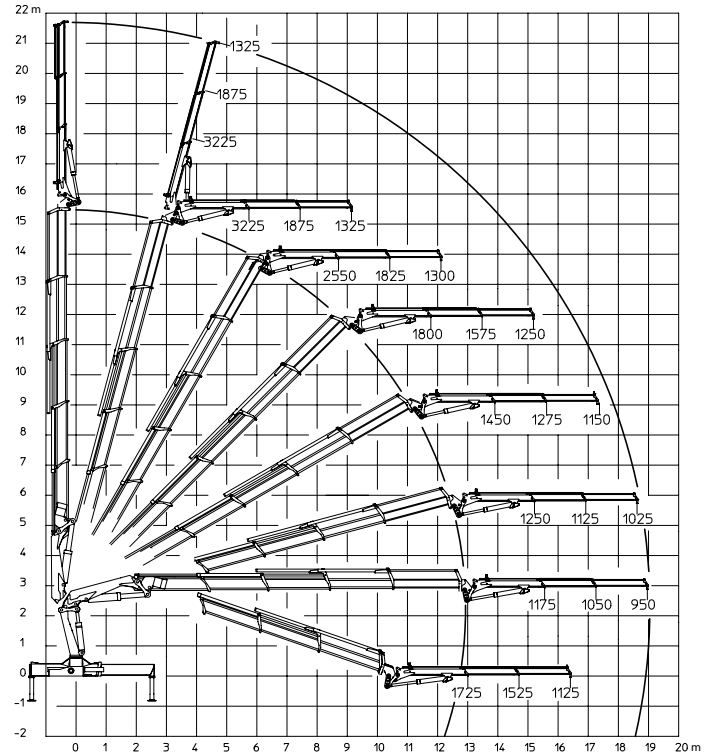

3450-K4 + FJ900-K3

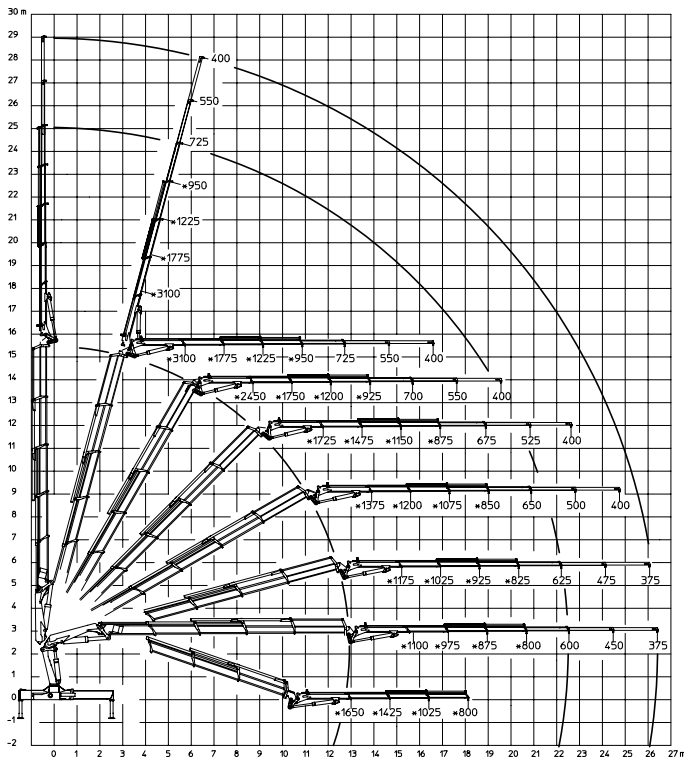

3450-K4 + FJ900-K4

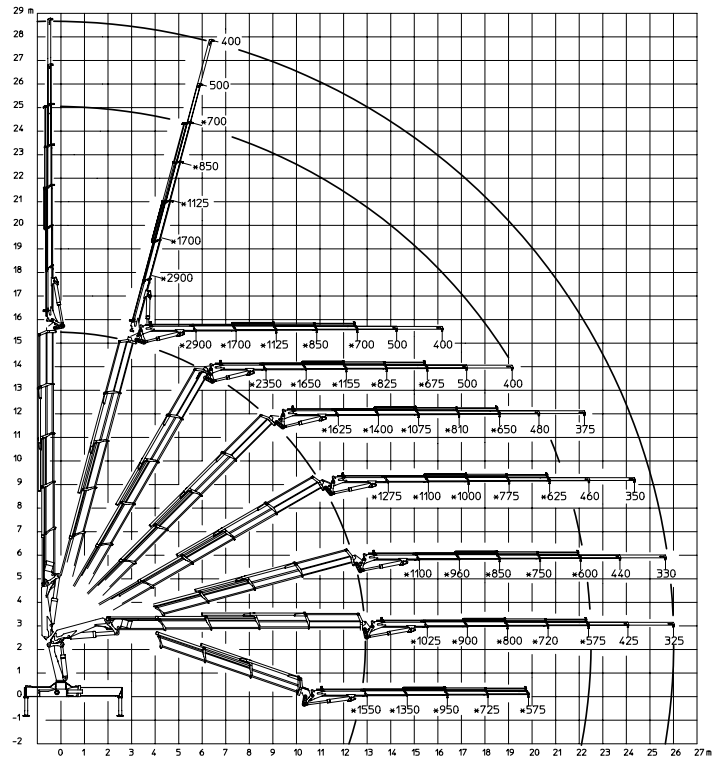

Z008233-4



Højbjerg Maskinfabrik A/S • Oddervej 200 • DK-8270 Højbjerg
Tel.: +45 8627 0800 • Fax: +45 8627 0744 • info@hmf.dk

www.hmf.dk

We reserve the right to introduce improvements and modifications